

AVR-Development Module with 128K Bytes external SRAM

Model: AL-ERAM128_256

Version 2.0

- Summary
- Measures
- Description
- Electrical Characteristics
- Programming
- Settings

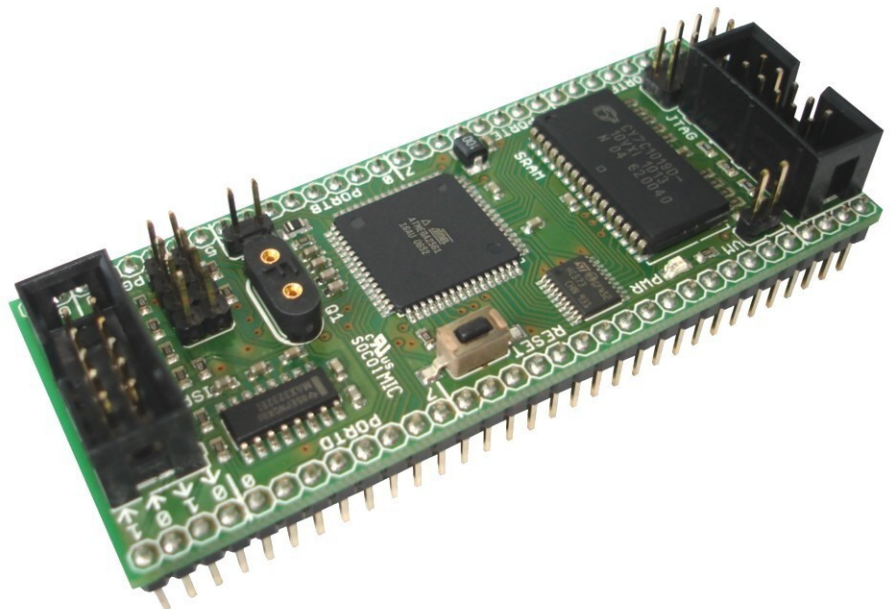

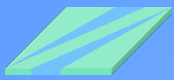

Summary

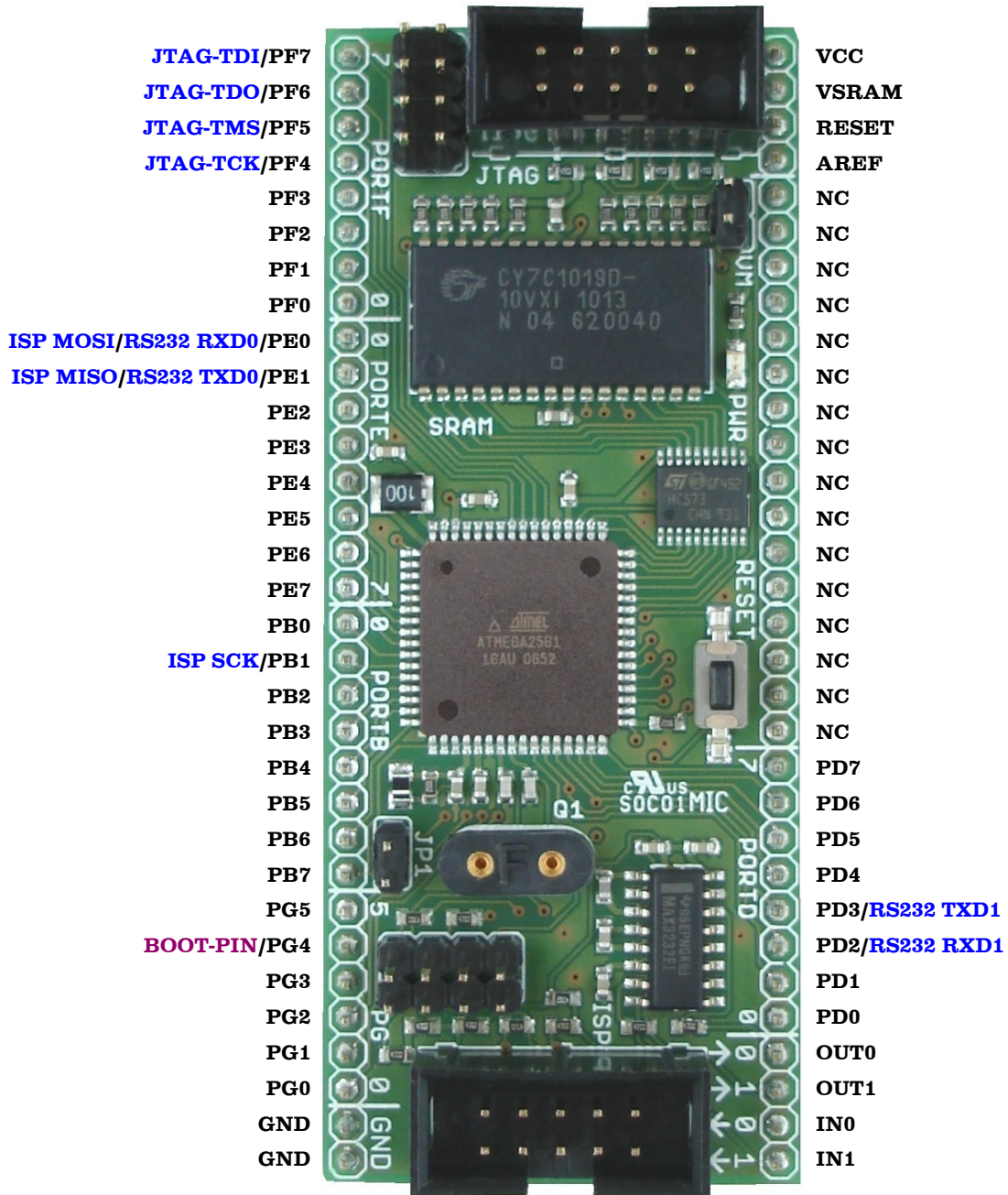

All description in **BLUE** concern the internal connection

Attention! Polarity reversal and overvoltage may cause a destruction of the electronic components!!!

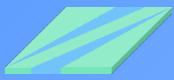

Measures

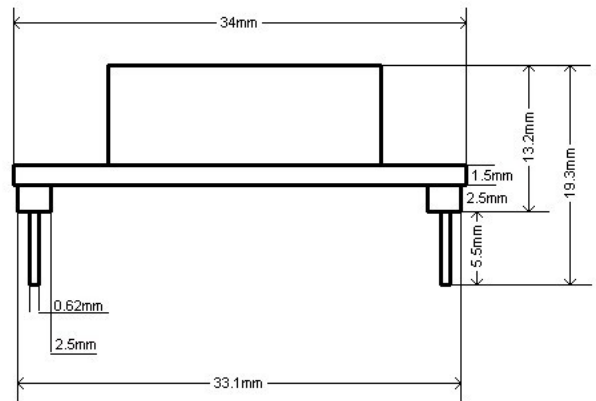
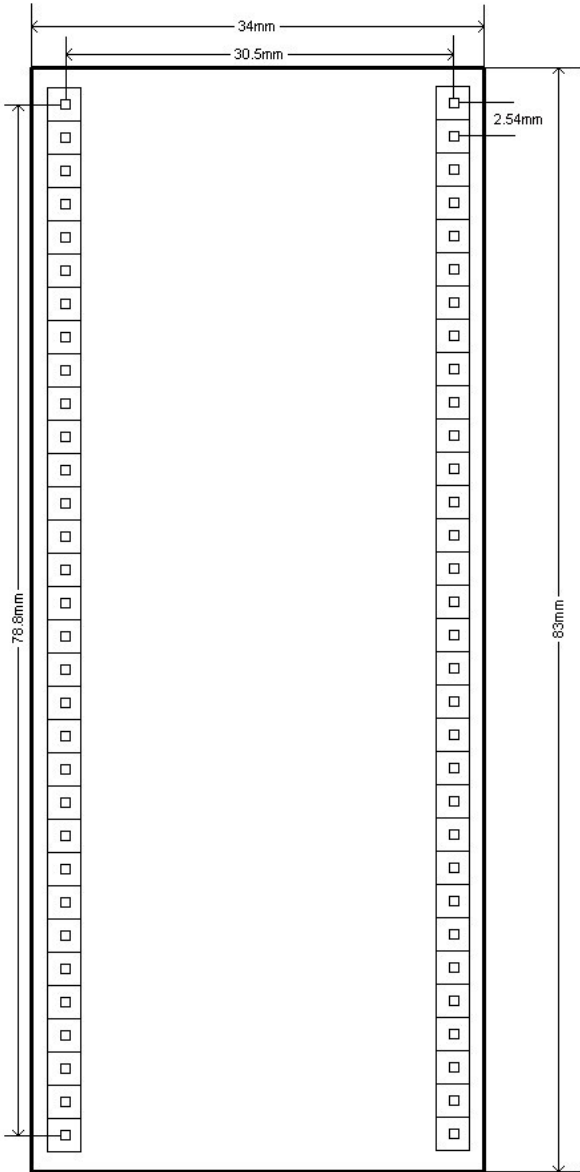

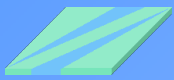

Description

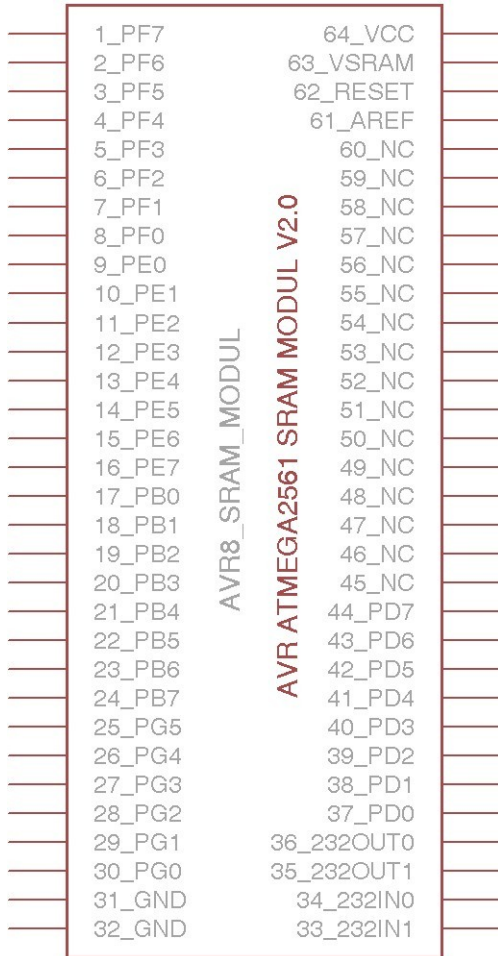

- **Controller:** Atmel AVR ATmega2561-16AU up to 16 MHz

- **Additional equipping:**

- external SRAM 128 KByte
- with 10 ns speed
- RS-232 Transceiver
- Reset key
- Power LED

- **External SRAM:** internal or external voltage

- **Supply voltage:** 5 V

- **Module size:** W x H x D 34 mm x 83 mm x 19.3 mm

- **Quartz socket:** simple and fast quartz exchange

- **PC-Connection:** 2 x RS232, separable with jumpers

- **Compatibility:** compatible with hole matrix board (hole distance 2.54 mm)

- **Circuit:** built on the recommendation of the manufacturer

- **Programming:** ISP or JTAG connector

- **Pin configuration of AVR-Module:** shown at the left picture

- **Pin configuration ISP & JTAG connectors:** 10-pin, standard of Atmel

- **Functionality:** tested, ready for use

- **Conformity:** **RoHS Compliance**

- **Produced** in Germany

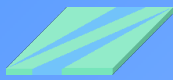

Electrical Characteristics

Min	Typ	Max
-----	-----	-----

for all modules with		Operating Temperature	
MAX3232EID	(actual)	- 40 °C	85 °C
MAX3232IDR	(actual)		

		Operating Voltage		
• with 5 V version	(actual)	4.5 V	5 V	5.5 V
• with 3.3 V version		3.0 V	3.3 V	3.6 V

		Operating Frequency		
• with 5 V version	(actual)	0 Hz		16 MHz
• with 3.3 V version		0 Hz		8 MHz

		Maximum DC Current per I/O Pin		
• with 5 V version	(actual)			20 mA
• with 3.3 V version				10 mA

		Maximum Access Time of SRAM		
• with 5 V version	(actual)			10 nS
• with 3.3 V version				10 nS

more electrical characteristics you will find on the page 370 in the data sheet [ATmega2561.pdf](#)

- ▶ 2-layer Leiterplatte DIN ISO 9001
- ▶ with UL-Approbation
- ▶ top-side mounted
- ▶ SRAM CY7C1019D
- ▶ Latch 74HC573

Possible Modifications

- 3.3V Version
- with mounted quartz (without quartz socket)
- without laterally pins

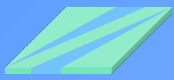

Programming

JTAG ¹

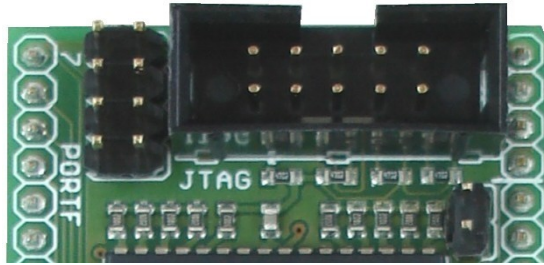

ISP ²

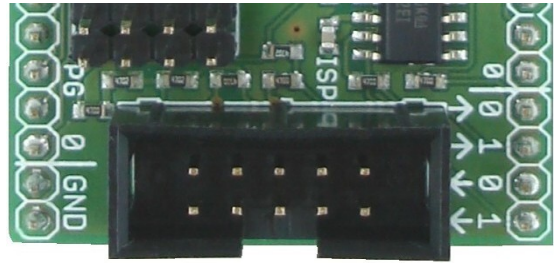

Pin Configuration JTAG-Connector

(9) TDI	(7) VCC	(5) TMS	(3) TDO	(1) TCK
(10) GND	(8)	(6) Reset	(4) VCC	(2) GND

Pin Configuration ISP-Connector

(2) VCC	(4) GND	(6) GND	(8) GND	(10) GND
(1) MOSI	(3) GND	(5) Reset	(7) SCK	(9) MISO

1 When programming with JTAG the JPI-(1-4)-jumpers should be set.

2 When programming with ISP the UART-jumpers JP2-3 and JP2-1 should not be set.

Settings

JTAG-jumpers

JP2-1	Pin: PF7
JP2-2	Pin: PF6
JP2-3	Pin: PF5
JP2-4	Pin: PF4

When programming with JTAG the jumpers should be set in the red square.

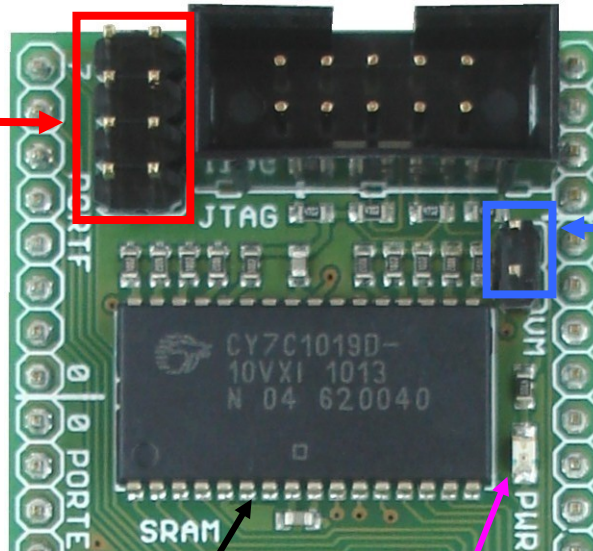

128 KByte external
SRAM

Power LED

VSRAM-jumper

If **JP3 is set**: internal SRAM power supply. On pin: VSRAM is a supply voltage applied

If **JP3 is not set**: only external SRAM power supply. Therewith the data buffering is possible, but only when the uninterruptible supply is guaranteed.

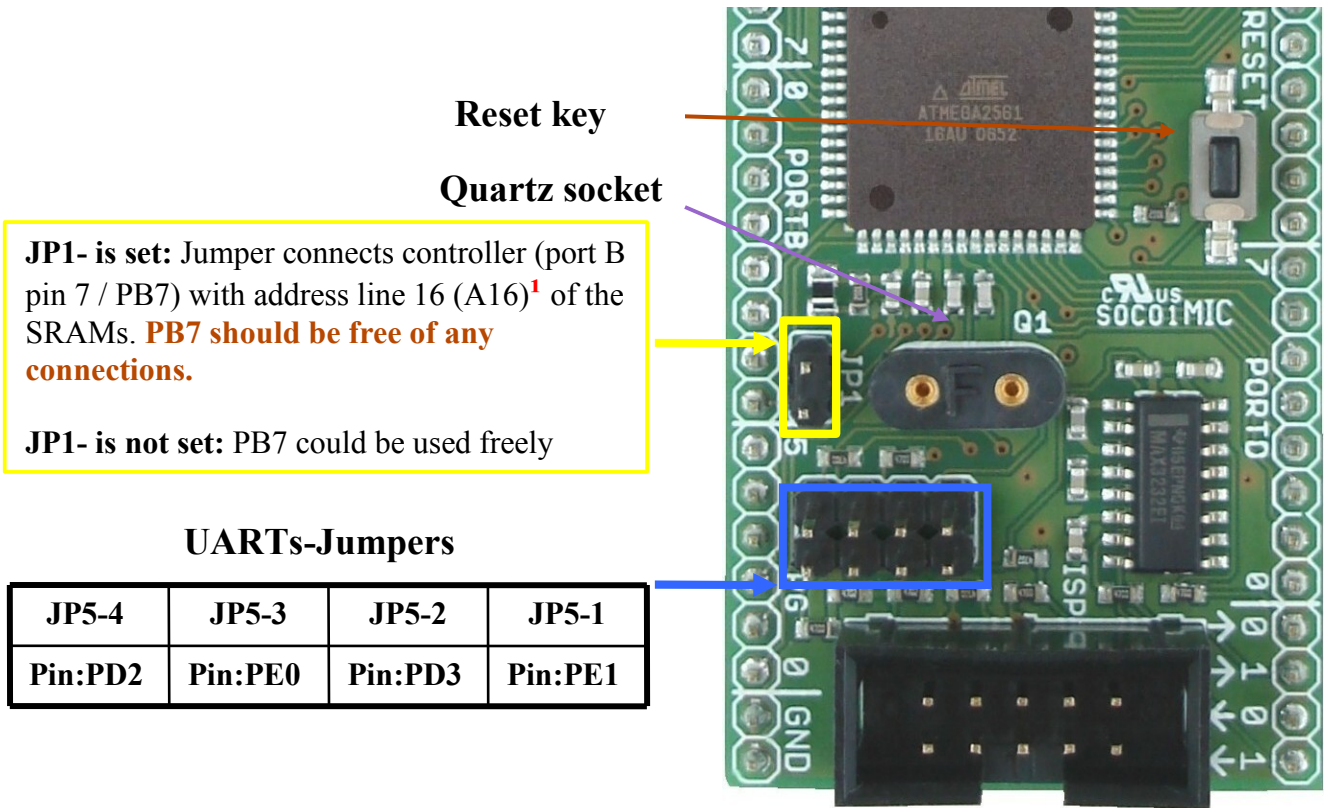

Reset key

Quartz socket

JP1- is set: Jumper connects controller (port B pin 7 / PB7) with address line 16 (A16)¹ of the SRAMs. **PB7 should be free of any connections.**

JP1- is not set: PB7 could be used freely

UARTs-Jumpers

JP5-4	JP5-3	JP5-2	JP5-1
Pin:PD2	Pin:PE0	Pin:PD3	Pin:PE1

The UARTs-pins can be parted from RS232 transceivers with these jumpers.

When programming with ISP the UART-jumpers JP5-3 (PE0) and JP5-1 (PE1) should not be set.

Connection of D-SUB 9-pin female connector (serial port/COM1)

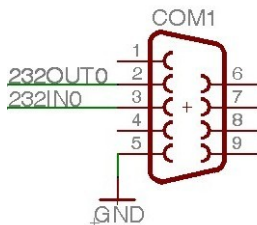

	D-SUB 9-p.	AL-ERAM128_256
CH 0 example in the left picture	Pin 2	36_232OUT0
	Pin 3	34_232IN0
	GND	32_GND
CH 1	Pin 2	35_232OUT 1
	Pin 3	33_232IN1
	GND	32_GND

¹ ATmega2561 could operate only up to 64 KByte external SRAM. If you need 128 KByte, you should operate manually. JP1(address line 16-A16) should be set.